

Alfa Laval Unique Mixproof Large Particle Valve (Unique LP)

Double seat valves

Introduction

The Alfa Laval Unique Mixproof Large Particle (LP) Valve is a versatile, highly flexible double block-and-bleed valve for the safe and efficient management of fluids at intersection points in matrix piped systems. The valve enables the simultaneous flow of two different products or fluids through the same valve without the risk of cross-contamination.

Modular design and a wide variety of options enable the valve to be customized to meet any process requirement—whether higher demands on cleanability, the ability to withstand high pressure by means of balanced plugs. The valve is designed for gentle handling of products containing large particulates up to 1¾" (45 mm) or products with high viscosity.

Application

The Alfa Laval Unique LP Mixproof Valve is designed for use in hygienic processes that require process safety and continuous flow management of fluids with large particles that require gentle handling across the dairy, food, beverage, and many other industries.

Benefits

- Enhanced product safety
- Spillage-free operation
- Optimized plant efficiency and enhanced cleanability
- Gentle product handling
- Easy maintenance

Standard design

The Alfa Laval Unique Mixproof LP Valve is comprised of a series of base components, including valve body, valve plug and actuator. There are two sizes: 4" and 6". The standard 6" valve comes equipped with balanced lower plug to protect against the effects of pressure peaks and water hammering. To accommodate 1¾" (45 mm) particles, the 4" valve is not equipped with a balanced lower plug but comes with a boost actuator to accommodate a product pressure of up to 10 bar.

Leakage detection holes enable visual inspection without requiring valve disassembly and provide advance notification of parts wear. Few straightforward moveable parts contribute to reliable operation and reduced maintenance costs.

Working principle

The Alfa Laval Unique Mixproof LP Valve is a normally closed (NC) valve controlled from a remote location by means of



compressed air. The valve has two independent plug seals to separate the liquids; the space between the seals forms a leakage chamber at atmospheric pressure during every working condition. Leakage rarely occurs but, should it occur, product flows into the leakage chamber and exits through the bottom outlet for easy detection.

When the valve is open, the leakage chamber is closed. The product then flows from one line to the other. The radial design of the valve ensures that virtually no product spillage occurs during valve operation.

Certificates

 Authorized to carry the 3A symbol

TECHNICAL DATA

Pressure

Max. product pressure:	1000 kPa (10 bar)
Min. product pressure:	Full vacuum
Air pressure:	Max. 8 bar

Temperature

Temperature range:	-5 °C to +125 °C (Depending on elastomer type)
--------------------	--

ATEX

Classification:	II 2 G D ¹
-----------------	-----------------------



Note! In order to use Unique Mixproof valves in ATEX environment, the blue plastic cover at lower plug must be removed for the valve types where the valve is delivered with the cover mounted

¹ This equipment is outside the scope of the directive 2014/34/EU and must not carry a separate CE marking according to the directive as the equipment has no own ignition source

PHYSICAL DATA

Materials

Product wetted steel parts:	1.4404 (316L)
Other steel parts:	1.4301 (304)
External surface finish	Semi-bright (blasted)
Internal surface finish	Bright (polished), Ra < 0.8 µm
Product wetted parts:	EPDM

Other seals:

CIP seals:	EPDM
Actuator seals:	NBR
Guide strips	PTFE

Availability

This LP edition of the Unique Mixproof valve is a high-end valve with regards to process security as well as from a hygienic point of view. The Unique Mixproof LP valve is available in 4" and 6" sizes.

Options

- Male parts or clamp liners in accordance with required standard
- Control and Indication: ThinkTop
- Side indication for detection of upper seat lift
- Product wetted seals in HNBR, NBR or FPM

Valve body combinations

TYPE 11-00

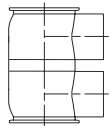

TYPE 11-90

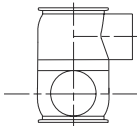

TYPE 11-180

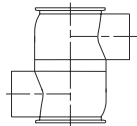

TYPE 11-270

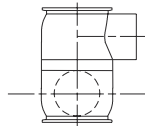

TYPE 12-00

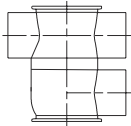

TYPE 12-90

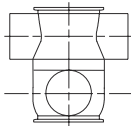

TYPE 21-00

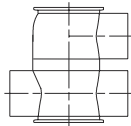

TYPE 21-90

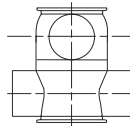

TYPE 22-00

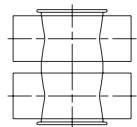

TYPE 22-90

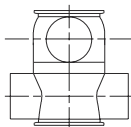

Pressure drop/capacity diagrams

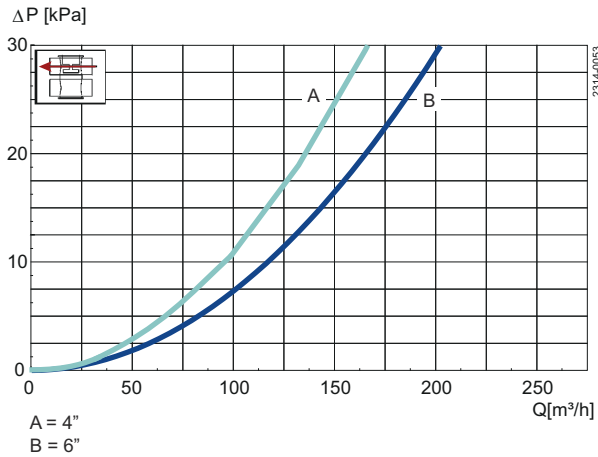

Figure 1. Pressure drop/capacity diagram, upper bodies

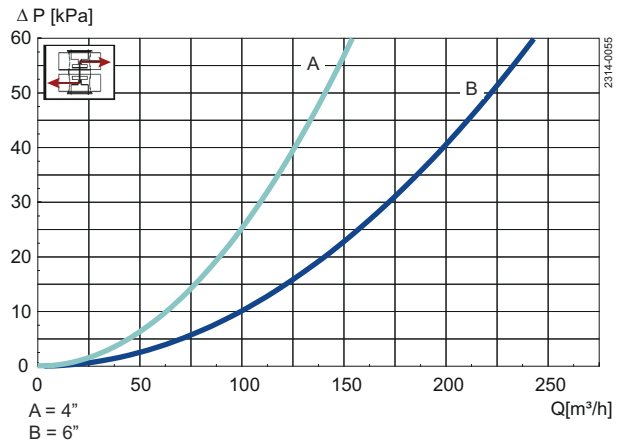

Figure 2. Pressure drop/capacity diagram, between bodies

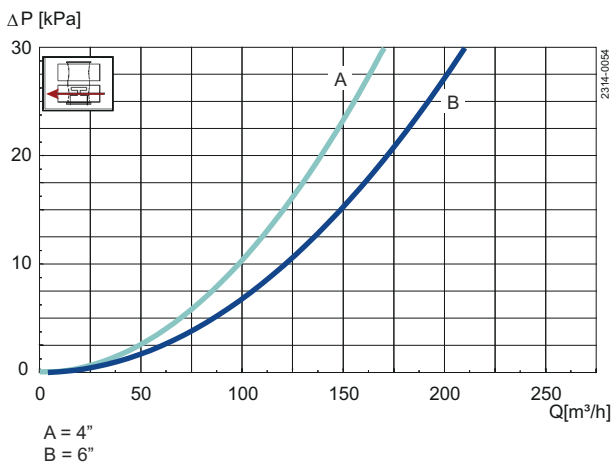

Figure 3. Pressure drop/capacity diagram, lower body



Note!

For the diagrams the following applies:
 Medium: Water (20 °C).
 Measurement: In accordance with VDI 2173.

Air and CIP consumption

Size	OD 4"	OD 6"
Kv-value		
Upper Seat-lift	[m³/h] 3.2	7.1
Lower Seat-lift	[m³/h] 2.9	6.0
Air consumption		
Upper Seat-lift	[n litre] ¹ 0.62	0.62
Lower Seat-lift	[n litre] ¹ 0.21	0.21
Main Movement	[n litre] ¹ 3.54	3.54

¹ [n litre] = volume at atmospheric pressure

Formula to estimate CIP flow during seat lift:

(for liquids with comparable viscosity and density to water):

$$Q = Kv \cdot \sqrt{\Delta p}$$

$$Q = \text{CIP - flow (m}^3\text{/h)}$$

Kv = Kv value from the above table

Δp = CIP pressure (bar)

Dimensions (mm)

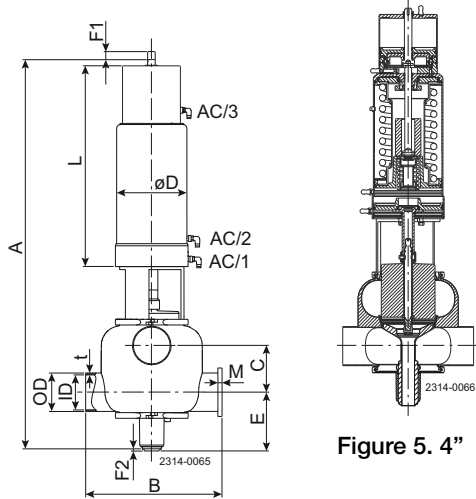

Figure 5. 4"

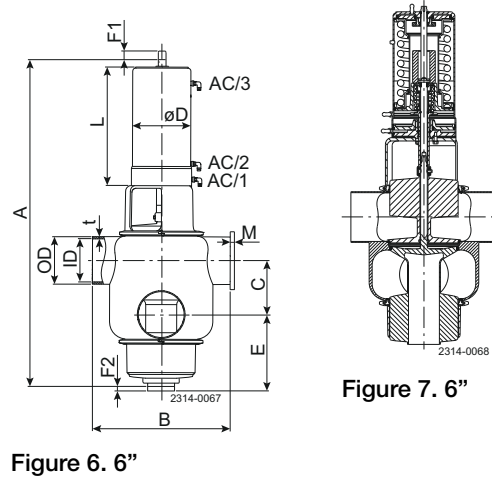

Figure 6. 6"

Figure 7. 6"

Figure 4. 4"

Size	4"	6"
A	1038.00	1002.00
B	350.00	440.00
C ¹	123.60	172.67
OD	101.60	152.40
ID	97.60	146.86
t	2.00	2.77
E	166.00	211.00
F1	75.00	75.00
F2	5.00	5.00
øD	186.00	186.00
L	534.00	379.00
M/Tri-clamp	21.00	38.60
Weight (kg)	64.90	86.20

¹ Note! The measure C can always be calculated by the formula $C = \frac{1}{2}ID_{\text{upper}} + \frac{1}{2}ID_{\text{lower}} + 26\text{mm}$.

This document and its contents are subject to copyrights and other intellectual property rights owned by Alfa Laval Corporate AB. No part of this document may be copied, re-produced or transmitted in any form or by any means, or for any purpose, without Alfa Laval Corporate AB's prior express written permission. Information and services provided in this document are made as a benefit and service to the user, and no representations or warranties are made about the accuracy or suitability of this information and these services for any purpose. All rights are reserved.

How to contact Alfa Laval

Up-to-date Alfa Laval contact details for all countries are always available on our website at www.alfalaval.com